

N-GV4090AORUS-X

GPU WATERBLOCK

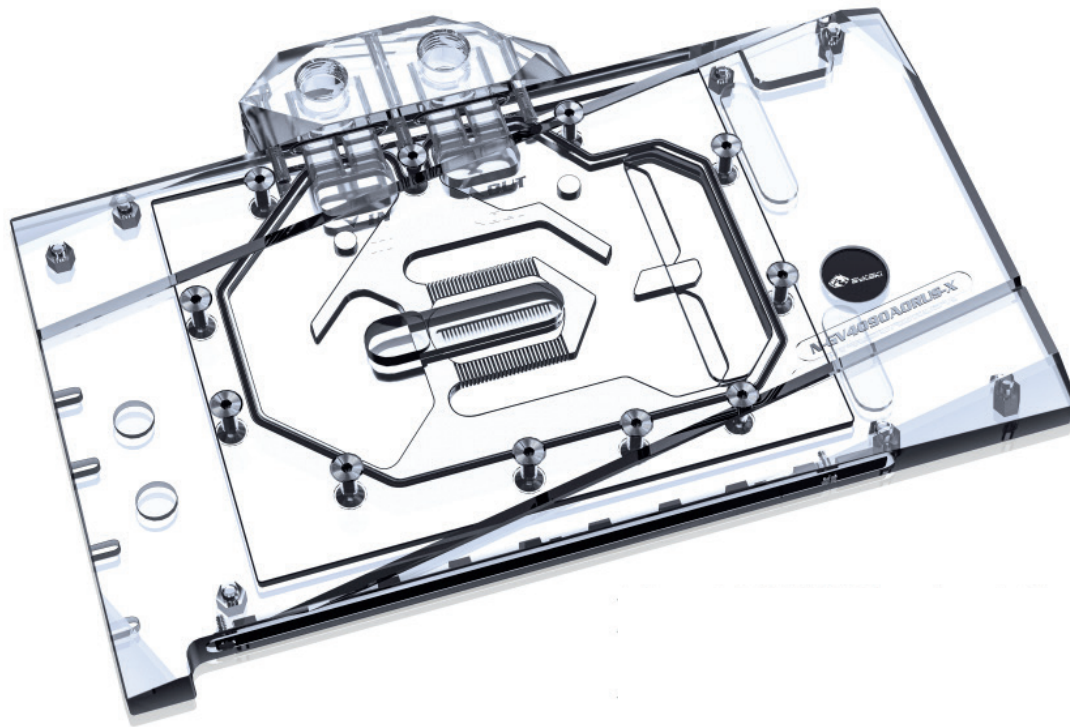

BLKSKI
EUROPE



- Imported MITSUBISHI acrylic materials
- Excellent thermal conductive T2 copper plate
- Jet type micro channel structure
- Large channel design, optimised flow



Jet Microchannel
0.5 mm

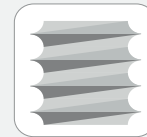

screw thread
G1/4'



Decorative pattern
Diamond cut



T2/Cu-ETP Copper

SAFETY AND WARRANTY INFORMATION

Before you start using this product, please follow these guidelines:

- Please carefully read the complete manual before beginning with the installation process.
- No liability is accepted for installation errors.
- Only use plastic, copper or brass components in the circuit. The use of other materials can lead to corrosion and other damage to the waterblock.
- Before mounting, please check the compatibility of the cooler with your GPU by comparing the PCB on page 2 with your GPU.
- All Bykski coolers are approved for use with „Aquacomputer DP-Ultra“ liquid only. The use of other fluids occurs at the user's own risk.
- Bykski GPU coolers must only be cleaned with distilled water, the use of other cleaning agents may damage the cooler! Never use cleaning agents containing alcohol or acid, this causes the destruction of the acrylic components and may attack the nickel plating!
- Tighten the screws and fittings carefully and firmly. Never use brute force.
- Make sure to thoroughly bleed air out of your water block, otherwise the cooling capacity may be limited.

TABLE OF CONTENT

page

COMPATIBILITY	2
BOX CONTENTS	3
PREPARATION OF THE GRAPHICS CARD	4
INSTALLATION OF THE WASHERS	5
INSTALLATION OF THE BLOCK	6
SUPPORT AND SERVICE	7
IMPRINT	8

MODDING

www.ezmodding.com

COMPATIBILITY

Before installing the waterblock, please ensure the compatibility.

Use our configurator: <https://ezmodding.com/en>

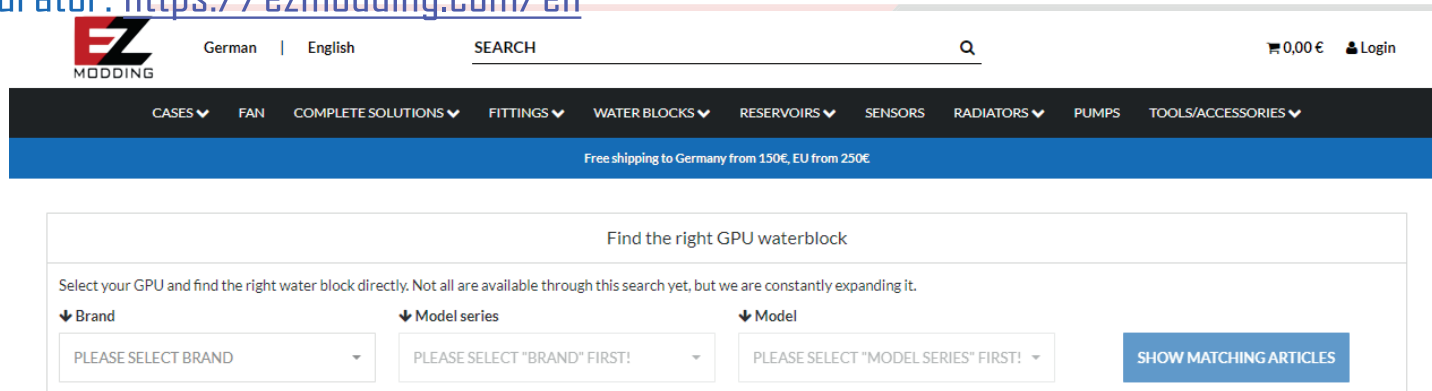

The screenshot shows the EZ Modding website interface. At the top, there is a navigation bar with the EZ Modding logo, language options (German | English), a search bar, and a shopping cart icon showing 0,00 € and a login button. Below the navigation bar is a menu with categories: CASES, FAN, COMPLETE SOLUTIONS, FITTINGS, WATER BLOCKS, RESERVOIRS, SENSORS, RADIATORS, PUMPS, and TOOLS/ACCESSORIES. A blue banner below the menu states "Free shipping to Germany from 150€, EU from 250€". The main content area is titled "Find the right GPU waterblock" and includes a sub-header "Select your GPU and find the right water block directly. Not all are available through this search yet, but we are constantly expanding it." Below this are three dropdown menus: "Brand" (PLEASE SELECT BRAND), "Model series" (PLEASE SELECT "BRAND" FIRST!), and "Model" (PLEASE SELECT "MODEL SERIES" FIRST!). A blue button labeled "SHOW MATCHING ARTICLES" is positioned to the right of the dropdowns.

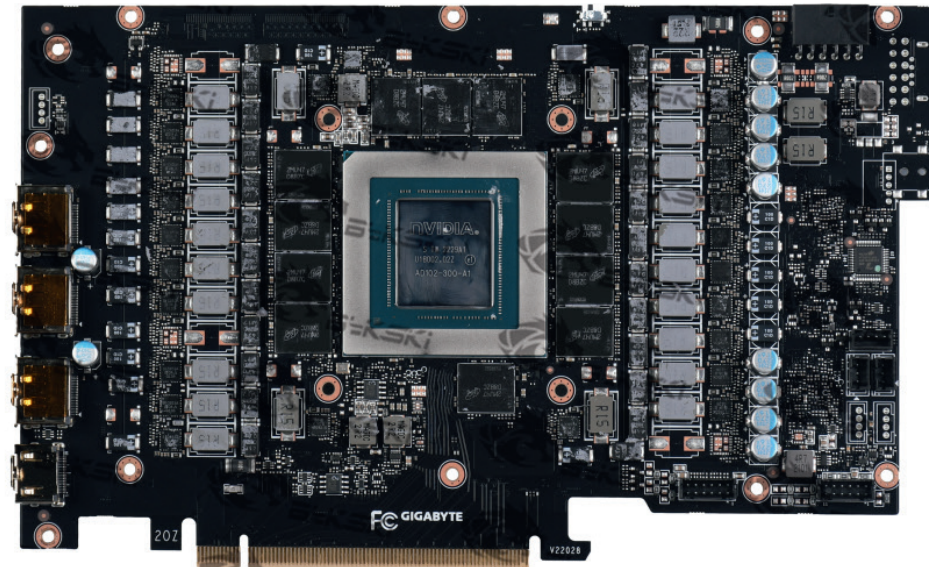

Compatible GIGABYTE GeForce RTX 4090 PCB

BOX CONTENTS

Dimensions in mm

Waterblock (1 pc)

233.01

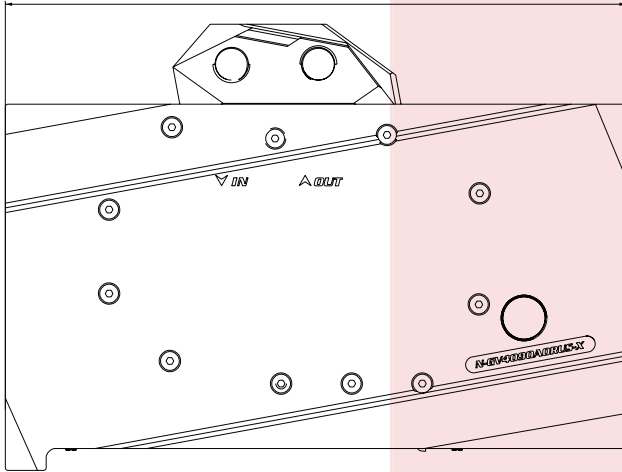

23.25

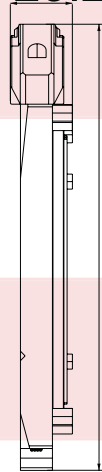

167.41

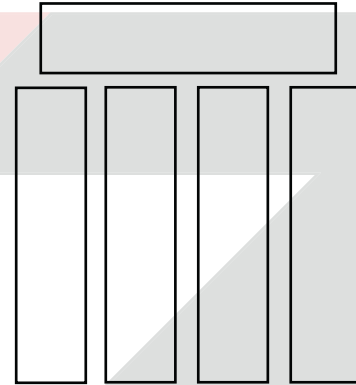

1,8mm THERMAL PAD
100x14mm (5 pcs)

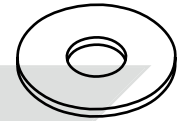

0,5mm WASHER (4 pcs)

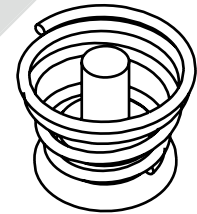

M2X5mm
SPRING SCREW (4 pcs)

232.51

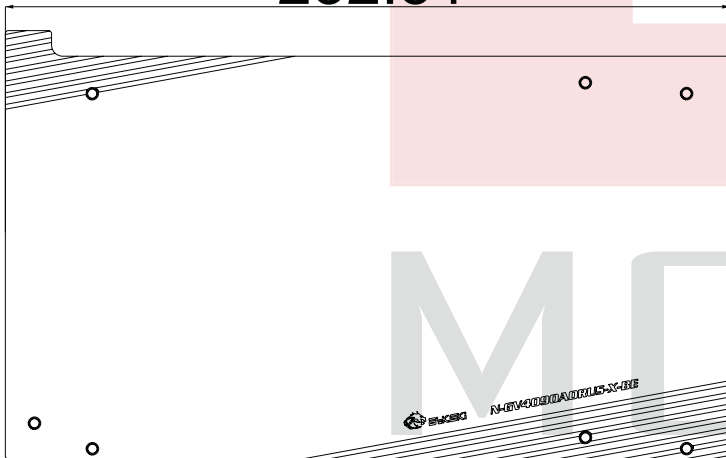

5.96



137.42

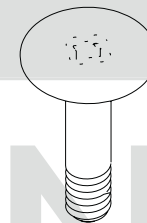

M2X9,5mm
SCREW (7 pcs)



WASHER
(7 pcs)

Backplate (1 pc)

www.ezmodding.com

PREPARATION OF THE GRAPHICS CARD

1. Remove the stock cooler.
2. Wipe off the thermal paste of the components using a nonabrasive cloth and remove the original thermal pads.
3. Check the position and number of screws on the block and test if the block fits your graphics card.
4. Cut the enclosed thermal pads to the right size for the front- and the backside of the graphics card (grey marked spaces on fig. 2).
5. Apply the thermal paste in a **thin and even** layer on the entire surface GPU chip (grey area on fig. 2) and the thermal pads to the indicated positions (yellow area on fig. 2).

Before using thermal pads

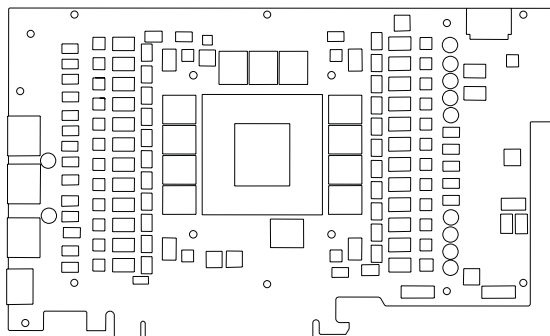

Clean the circuit and chip and wipe off the original thermal pads

Cut the thermal pads to proper size

After using thermal pads

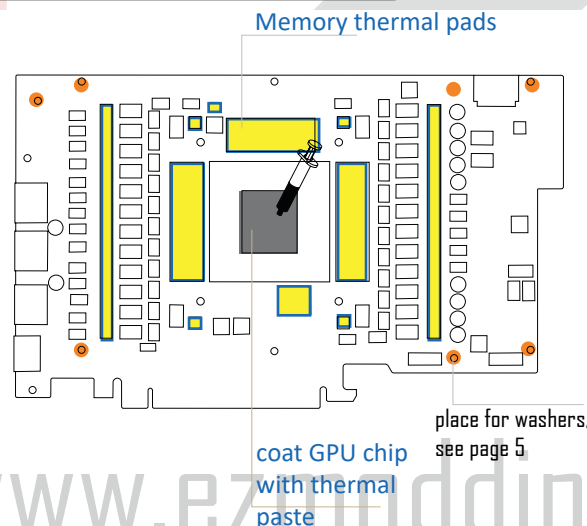

fig. 2



- ① **No** thermal pads are required on the **coils!**
- ② The memory and VRMs marked in yellow **MUST** be covered with thermal pads, otherwise the graphics card may **get damaged.**

fig. 1

INSTALLATION OF THE WASHERS

This figure is an example. The position, number and constallation of the screws in the acrylic material of the waterblock may vary.

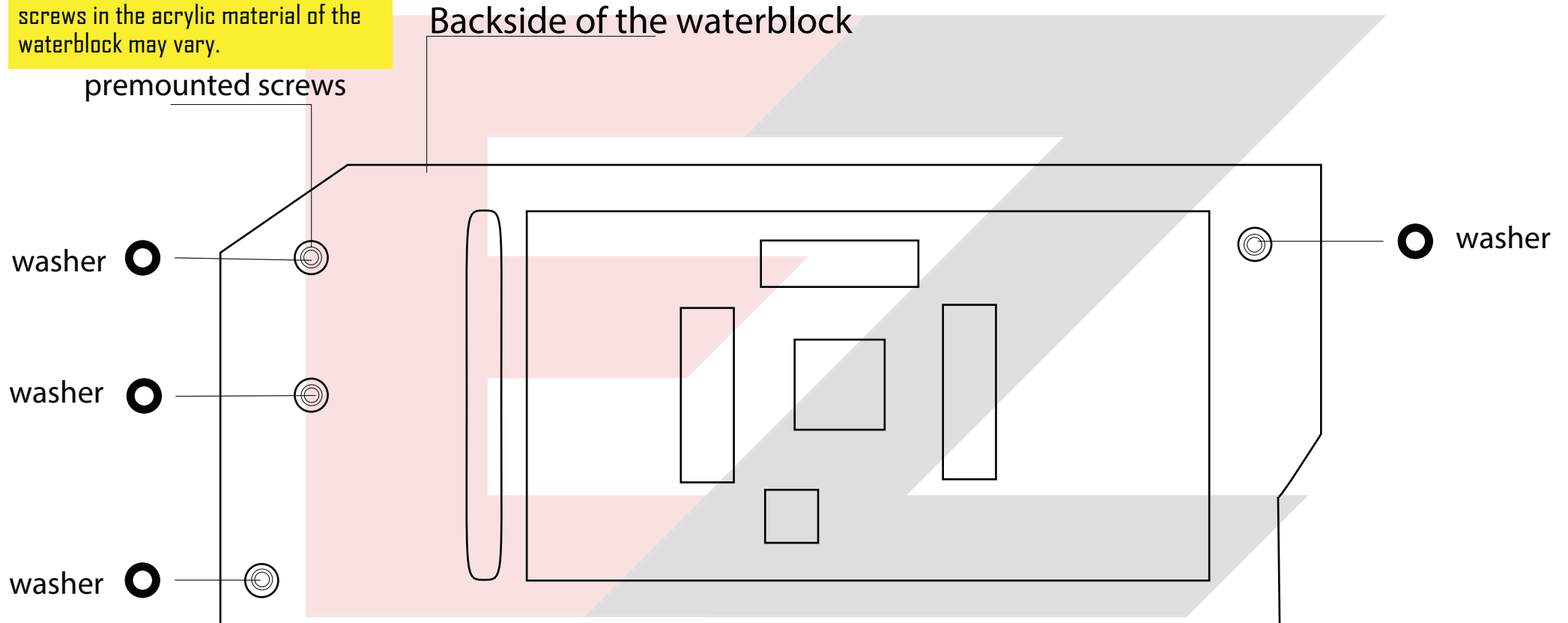

The washers belong on the backside of the waterblock. Put them on the pre-mounted screws in the acrylic material. They ensure the right space between the waterblock and the graphics card (marked orange on fig. 2 on page 4)

INSTALLATION OF THE BLOCK

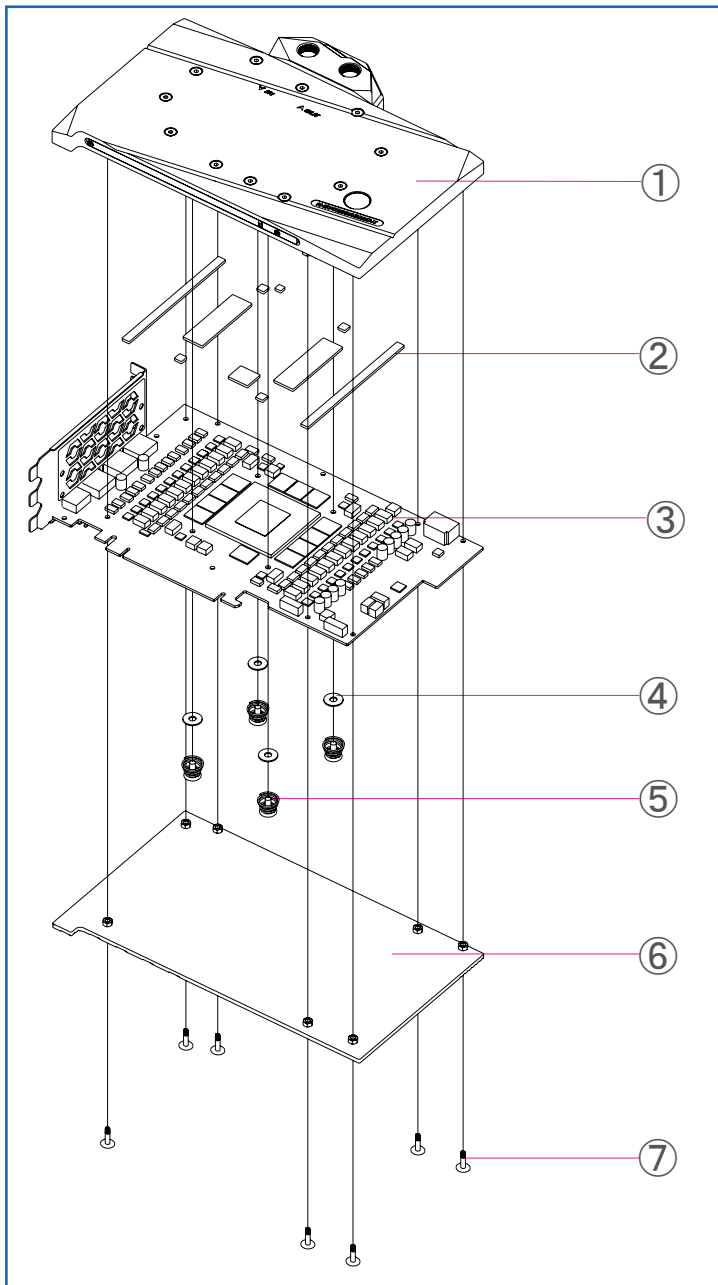

If you notice that the block and the graphics PCB do not fit, do not force the block into place, it could cause damage. Contact a technician (support@ezmodding.com).

1. Carefully place the PCB of the graphics card **on top** of the **block** (1).
2. Attach the **block** (1) to the graphics PCB and align the **washer** (4) and the **M2X5mm spring screws** (5) with the screw holes of the graphics card and tighten it carefully.
3. Place the **backplate** (6) **on the back** of the graphics card and secure it **carefully** with the **M2X9.5mm screws** (7) in the corresponding position of the screw holes.

1. Waterblock
2. 1,8mm thermal pads
3. Graphics card
4. 0,5mm washer
5. M2X5mm spring screw
6. Backplate
7. M2X9.5mm aluminium screws

SUPPORT AND SERVICE

In case you have any questions regarding our product or need assistance, please contact:

support@ezmodding.com

You can also use our contact form:

<https://ezmodding.com/contact>

Visit us on:

 <https://www.facebook.com/ezmodding>

 EZModding

 www.ezmodding.com

MODDING
www.ezmodding.com

IMPRINT

IMPKON GmbH & Co.KG

Sabinastraße 30

45136 Essen

Germany

E-Mail: support@ezmodding.com

MODDING

www.ezmodding.com